

AAO

Integrating the Healthcare Enterprise



**IHE EYE CARE
Technical Framework
Year 2: 2008**

**Volume II
Transactions**

Revision 3.2

Final Text Version

Publication Date: February 5, 2008

Copyright © 2008: AAO, HIMSS, RSNA

Contents

1	Introduction.....	5
1.1	Overview of Technical Framework.....	5
1.2	Overview of Volume II	5
1.3	Audience.....	6
1.4	Relationship to Standards	6
1.5	Relationship to Real-world Architectures	7
1.6	Comments.....	7
1.7	Copyright Permission	7
2	Conventions	8
2.1	The Generic IHE Transaction Model	8
2.2	DICOM Usage Conventions.....	9
2.3	Use of Coded Entities and Coding Schemes	11
3	Framework Overview	12
4	IHE Transactions	13
4.1	Query Modality Worklist [EYECARE-1]	13
4.1.1	Scope 13	
4.1.2	Use Case Roles.....	13
4.1.3	Referenced Standards	14
4.1.4	Interaction Diagram.....	14
4.1.5	Issuer of Patient ID.....	15
4.2	Modality Images/Evidence Stored [EYECARE-2]	16
4.2.1	Scope 16	
4.2.2	Use Case Roles.....	16
4.2.3	Referenced Standards	16
4.2.4	Interaction Diagram.....	17
4.2.5	EYE CARE Image Option	18
4.2.6	Encapsulated PDF Option for Evidence Documents	20
4.2.7	Eye Care Measurements Option.....	20
4.3	Retrieve Images and Measurements [EYECARE-3]	21
4.3.1	Scope 21	
4.3.2	Use Case Roles.....	21
4.3.3	Referenced Standards	22
4.3.4	Interaction Diagram.....	22
4.3.5	EYE CARE Image Option	23
4.4	Query Evidence Documents [EYECARE-4].....	23
4.4.1	Scope 23	
4.4.2	Use Case Roles.....	23
4.4.3	Referenced Standards	24
4.4.4	Interaction Diagram.....	24
4.4.5	DICOM Encapsulated PDF Query Attributes.....	25
4.5	Query Images, Measurements and Encapsulated Documents [EYECARE-5]	25

4.5.1	Scope	25
4.5.2	Use Case Roles	25
4.5.3	Referenced Standards	26
4.5.4	Interaction Diagram	26
4.5.5	Support Issuer of Patient ID	27
4.6	Modality Procedure Step Completed/Discontinued [EYECARE-6]	27
4.6.1	Scope	27
4.6.2	Use Case Roles	28
4.6.3	Referenced Standards	28
4.6.4	Interaction Diagram	28
4.7	Displayable Report Storage [EYECARE-7]	31
4.7.1	Scope	31
4.7.2	Use Case Roles	32
4.7.3	Referenced Standards	32
4.7.4	Interaction Diagram	32
4.7.5	DICOM Encapsulated Document Standard Extended Attributes	34
4.8	Query Displayable Report [EYECARE-8]	36
4.8.1	Scope	36
4.8.2	Use Case Roles	36
4.8.3	Referenced Standards	37
4.8.4	Interaction Diagram	37
4.9	Retrieve Displayable Reports [EYECARE-9]	40
4.9.1	Scope	40
4.9.2	Use Case Roles	40
4.9.3	Referenced Standards	40
4.9.4	Interaction Diagram	41

Foreword

Integrating the Healthcare Enterprise (IHE) is an initiative designed to stimulate the integration of the information systems that support modern healthcare institutions. Its fundamental objective is to ensure that in the care of patients all required information for medical decisions is both correct and available to healthcare professionals. The IHE initiative is both a process and a forum for encouraging integration efforts. It defines a technical framework for the implementation of established messaging standards to achieve specific clinical goals. It includes a rigorous testing process for the implementation of this framework. And it organizes educational sessions and exhibits at major meetings of medical professionals to demonstrate the benefits of this framework and encourage its adoption by industry and users.

The approach employed in the IHE initiative is not to define new integration standards, but rather to support the use of existing standards, HL7, DICOM, IETF, and others, as appropriate in their respective domains in an integrated manner, defining configuration choices when necessary. When clarifications or extensions to existing standards are necessary, IHE refers recommendations to the relevant standards bodies.

This initiative has numerous sponsors and supporting organizations in different medical specialty domains and geographical regions. In North America the primary sponsors are the American Academy of Ophthalmology (AAO), the Healthcare Information and Management Systems Society (HIMSS) and the Radiological Society of North America (RSNA). IHE Canada has also been formed. IHE Europe (IHE-EUR) is supported by a large coalition of organizations including the European Society of Cardiology (ESC), European Association of Radiology (EAR) and European Congress of Radiologists (ECR), the Coordination Committee of the Radiological and Electromedical Industries (COCIR), Deutsche Röntgenesellschaft (DRG), the EuroPACS Association, Groupement pour la Modernisation du Système d'Information Hospitalier (GMSIH), Société Française de Radiologie (SFR), and Società Italiana di Radiologia Medica (SIRM). In Japan IHE-J is sponsored by the Ministry of Economy, Trade, and Industry (METI); the Ministry of Health, Labor, and Welfare; and MEDIS-DC; cooperating organizations include the Japan Industries Association of Radiological Systems (JIRA), the Japan Association of Healthcare Information Systems Industry (JAHIS), Japan Radiological Society (JRS), Japan Society of Radiological Technology (JSRT), and the Japan Association of Medical Informatics (JAMI). Other organizations representing healthcare professionals are invited to join in the expansion of the IHE process across disciplinary and geographic boundaries.

The IHE Technical Frameworks for the various domains (IT Infrastructure, Cardiology, Laboratory, Radiology, Eye Care etc.) defines specific implementations of established standards to achieve integration goals that promote appropriate sharing of medical information to support optimal patient care. It is expanded annually, after a period of public review, and maintained regularly through the identification and correction of errors. The current version for these Technical Frameworks may be found at www.aao.org, www.rsna.org/IHE or <http://www.himss.org/IHE>, or www.ihe.net.

The IHE Technical Frameworks identify a subset of the functional components of the healthcare enterprise, called IHE Actors, and specify their interactions in terms of a set of coordinated, standards-based transactions. They describe this body of transactions in progressively greater depth. This volume I provides a high-level view of IHE functionality, showing the transactions organized into functional units called Integration Profiles that highlight their capacity to address specific clinical needs. The subsequent volumes provide detailed technical descriptions of each IHE transaction.

Comments arising from Final Text may be submitted to:

**<http://forums.rsna.org> under the “*Integrating the Healthcare Enterprise*”
forum**

**Select the “*IHE Eye Care Technical Framework version 3.2 Final Text*” sub-
forum.**

1 Introduction

1.1 Overview of Technical Framework

This document, the IHE Eye Care Technical Framework (IHE EYECARE-TF), defines specific implementations of established standards to achieve integration goals for eye care. Such integration promotes appropriate sharing of medical information to support optimal patient care.

The EYECARE-TF is expanded annually, after a period of public review, and maintained regularly through the identification and correction of errors. The latest version of the document is always available via the Internet at www.aao.org.

The EYECARE-TF identifies a subset of the functional components of the healthcare enterprise, called IHE actors, and specifies their interactions in terms of a set of coordinated, standards-based transactions. It describes this body of transactions in progressively greater depth. The present Volume I provides a high-level view of IHE functionality, showing the transactions organized into functional units called Integration Profiles that highlight their capacity to address specific clinical needs. Volume II provides detailed technical descriptions of each eye care specific IHE transaction.

The EYECARE-TF is part of a related set of IHE Technical Frameworks, inclusive of the following domain-specific documents:

- IHE Eye Care Technical Framework
- IHE Cardiology Technical Framework
- IHE IT Infrastructure Technical Framework
- IHE Radiology Technical Framework
- IHE Laboratory Technical Framework
- Others.....

The IHE Eye Care Integration Profiles rely heavily on, and reference, the transactions defined in those other IHE Technical Framework documents. For the conventions on referencing other frameworks, see Section 1.6.4 in Volume 1.

1.2 Overview of Volume II

Section 2 presents the conventions used in this volume to define the transactions implemented under IHE.

Section 3 provides an overview of the concepts of IHE actors and transactions used in IHE to define the functional components of a distributed healthcare environment.

Section 4 defines transactions EYECARE-1 to EYECARE-9 in detail, specifying the roles for each actor, the standards employed, the information exchanged.

The appendices following the main body of this volume provide clarification of technical details of the IHE data model and transactions. A glossary of terms and acronyms used in the IHE Technical Framework, including those from relevant standards (currently HL7 and DICOM), is provided in Volume I.

1.3 Audience

The intended audience of this document is:

- Clinicians interested in the technical aspects of integrating healthcare information systems
- Technical staff of vendors participating in the IHE initiative
- IT departments of healthcare institutions
- Experts involved in standards development

1.4 Relationship to Standards

The IHE Technical Framework identifies functional components of a distributed healthcare environment (referred to as IHE Actors), solely from the point of view of their interactions in the healthcare enterprise. At its current level of development, it defines a coordinated set of transactions based on the HL7, DICOM, and various Web standards. As the scope of the IHE initiative expands, transactions based on other standards will be included as required.

In some cases, IHE recommends selection of specific options supported by these standards; however, IHE does not introduce technical choices that contradict conformance to these standards. If errors in or extensions to existing standards are identified, IHE's policy is to report them to the appropriate standards bodies for resolution within their conformance and standards evolution strategy.

IHE is therefore an implementation framework, not a standard. Referencing IHE as a standard is inappropriate. Conformance claims by product must still be made in direct reference to specific standards. In addition, vendors that have implemented IHE integration capabilities shall use an IHE Integration Statement to describe the conformance of their product to the specifications in the IHE Technical Framework. The purpose of an IHE Integration Statement is to communicate to the users of the corresponding product the IHE capabilities it has been designed to support. Vendors publishing IHE Integration Statements accept full responsibility for their content. By comparing the IHE Integration Statements from different implementations, a user familiar with the IHE concepts of Actors and Integration Profiles should be able to determine whether and to what extent communications might be supported between products. IHE encourages implementers to ensure that products implemented in accordance with the IHE Technical Framework also meet the full requirements of the standards underlying IHE, allowing the products to interact, although possibly at a lower level of integration, with products that have been implemented in conformance with those standards, but not in full accordance with the IHE Technical Framework.

1.5 Relationship to Real-world Architectures

The IHE Actors and transactions described in the IHE Technical Framework are abstractions of the real-world healthcare information system environment. While some of the transactions are traditionally performed by specific product categories (e.g. Hospital Information System (HIS), Electronic Health Record, Practice Management Systems, Image Management Systems, or acquisition modalities), the IHE Technical Framework intentionally avoids associating functions or actors with such product categories. For each actor, the IHE Technical Framework defines only those functions associated with integrating information systems. The IHE definition of an actor should therefore not be taken as the complete definition of any product that might implement it, nor should the framework itself be taken to describe the architecture of a healthcare information system comprehensively.

The reason for defining actors and transactions is to provide a basis for defining the interactions among functional components of the healthcare information system environment. In situations where a single physical product implements multiple functions, only the interfaces between the product and external functions in the environment are considered to be significant by the IHE initiative. Therefore, the IHE initiative takes no position as to the relative merits of an integrated environment based on a single, all-encompassing information system versus one based on multiple systems that together achieve the same end. To illustrate most dramatically the possibilities of the IHE Technical Framework, however, the IHE demonstrations emphasize the integration of multiple vendors' systems based on the IHE Technical Framework.

1.6 Comments

The AAO welcomes comments on this document and the IHE initiative. They should be directed to the discussion server at <http://forums.rsna.org/> or to:

Flora Lum, M.D.

Policy Director, Quality of Care and Knowledge Base Development

American Academy of Ophthalmology

e-mail: flum@ao.org

1.7 Copyright Permission

Health Level Seven, Inc., has granted permission to the IHE to reproduce tables from the HL7 standard. The HL7 tables in this document are copyrighted by Health Level Seven, Inc. All rights reserved.

The National Electrical Manufacturers Association (NEMA) has granted permission to the IHE to incorporate portions of the DICOM standard.

Material drawn from these documents is credited where used.

2 Conventions

This document has adopted the following conventions for representing the framework concepts and specifying how the standards upon which the IHE Technical Framework is based shall be applied.

2.1 The Generic IHE Transaction Model

Transaction descriptions are provided in section 4. In each transaction description, the actors, the roles they play, and the transactions between them are presented as use cases.

The generic IHE transaction description includes the following components:

- **Scope:** a brief description of the transaction.
- **Use case roles:** textual definitions of the actors and their roles, with a simple diagram relating them, e.g.:

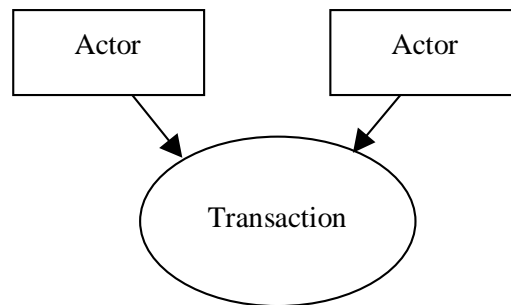

- *Referenced Standards:* the standards (stating the specific parts, chapters or sections thereof) to be used for the transaction.
- *Interaction Diagram:* a graphical depiction of the actors and transactions, with related processing within an actor shown as a rectangle and time progressing downward, similar to:

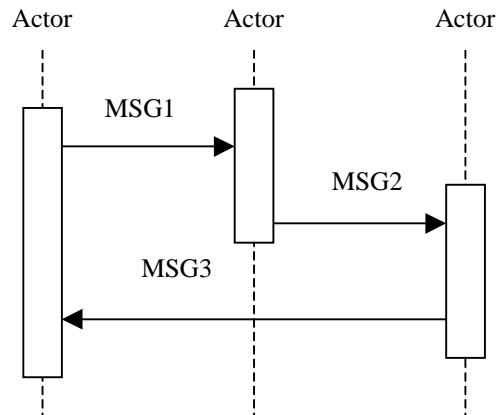

The interaction diagrams used in the IHE Technical Framework are modeled after those described in Grady Booch, James Rumbaugh, and Ivar Jacobson, *The Unified Modeling Language User Guide*, ISBN 0-201-57168-4. Simple acknowledgment messages are omitted from the diagrams for brevity.

- *Message definitions*: descriptions of each message involved in the transaction, the events that trigger the message, its semantics, and the actions that the message triggers in the receiver.

2.2 DICOM Usage Conventions

For some DICOM transactions described in this document, IHE has strengthened the requirements on the use of selected Type 2 and Type 3 attributes. These situations are explicitly documented in section 4 and in the appendices.

IHE specifically emphasizes that DICOM Type 2 attributes (for instance, Patient Name, Patient ID) shall be transmitted with zero length if the source system does not possess valid values for such attributes; in other words, the source system shall not assign default values to such attributes. The receiving system must be able to handle zero-length values for such attributes.

IHE has also defined requirements related to the support for and use of matching and return keys in DICOM queries by both Service Class Users (SCUs) and Service Class Providers (SCPs). Matching keys are used to select instances for inclusion in the response by the query SCP to the SCU, whereas return keys only return specific data and are not used for matching.

- Required matching key SCU:
A key that the Query SCU shall have the ability to offer to its user as a selection criterion. The definition of the means offered to the user of the Query SCU to trigger the sending of a matching key in the Query request is beyond the scope of IHE (e.g. enter a value, select an entry).

- Required matching key SCP:
An IHE required matching key is processed by the Query SCP just as if it were a DICOM-required matching key. In most cases, IHE-required matching keys are also DICOM-required matching keys.
- Required return key SCU:
A key that the Query SCU requests from the Query SCP, receives in the query responses, and displays for the user, if required. The definition of the means offered to the user of the Query SCU to request a return key (e.g. by default, check a box) and to make it visible to the user is beyond the scope of IHE.
- Required return key SCP:
IHE-required return keys specified within DICOM as type 1 or type 2 return keys are processed according to their DICOM type. IHE-required return keys specified within DICOM as type 3 will be processed as if they were type 2.

Query Key Requirement Tables in the framework use the following legend to specify requirements for SCUs and SCPs:

- R Required
- O Optional

The following modifiers are also used:

- R+ The Requirement is an IHE extension of the DICOM requirements
- R* The attribute is not required to be displayed

Table 2.2-1 provides an example table defining matching and return keys.

Table 2.2-1. Images Query Matching and Return Keys

Attributes Name	Tag	Query Keys Matching		Query Keys Return		Notes
		SCU	SCP	SCU	SCP	
Scheduled Human Performers Sequence	(0040,4034)	R+	R	R+*	R	
>Human Performer Code Sequence	(0040,4009)	R+	R	R+*	R	
>>Code Value	(0008,0100)	R+	R	R+*	R	
>>Coding Scheme Designator	(0008,0102)	R+	R	R+*	R	
>>Code Meaning	(0008,0104)	-	-	R+	R	Query Keys Matching SCU or SCP do not use the Code Meaning values (“-“).

>Human Performer's Name	(0040,4037)	R+	R+	R+	R+	
>Human Performer's Organization	(0040,4036)	O	O	O	R+	
Referenced Study Component Sequence	(0008,1111)	O	O	O	O	
>Referenced SOP Class UID	(0008,1150)	O	O	O	R	
>Referenced SOP Instance UID	(0008,1155)	O	O	O	R	
Input Information Sequence	(0040,4021)	O	O	R+*	R	

2.3 Use of Coded Entities and Coding Schemes

IHE does not produce, maintain or otherwise specify a coding scheme or other resource for controlled terminology (coded entities). Where applicable, coding schemes required by the HL7 and DICOM standards take precedence. In the cases where such resources are not explicitly identified by the standards, implementations may utilize any resource (including proprietary or local) provided any licensing/copyright requirements are satisfied.

3 Framework Overview

The IHE Technical Framework is based on actors that interact through transactions.

Actors are information systems or components of information systems that produce, manage, or act on information associated with operational activities in the enterprise.

Transactions are interactions between actors that transfer the required information through standards-based messages.

Specific sets of actors and transactions are specified in the Integration Profiles (see EYECARE-TF 1).

4 IHE Transactions

This section defines each IHE transaction in detail, specifying the standards used, the information transferred, and the conditions under which the transaction is required or optional.

4.1 Query Modality Worklist [EYECARE-1]

This transaction is identical to Query Modality Worklist [RAD-5] (see RAD-TF 2: 4.5), with the addition of some features.

Note-1: The Radiology TF requires that the Acquisition Modality support at least one of the Worklist Query choices (i.e. Patient and/or Broad). Eye Care requires support for both options. See EYECARE-TF 1:3.2.

4.1.1 Scope

This transaction takes place at the Acquisition Modality at the point of scan/acquisition. When a patient arrives for the scheduled procedure, the user performing the procedure must examine key information elements as they relate to the procedure, the correctness of the procedure that has been ordered, and comments that may have been entered by the referring physician. The user at the Acquisition Modality uses the DICOM Modality Worklist to query the Department System Scheduler/Order Filler for Scheduled Procedure Steps. The list is downloaded to the Acquisition Modality and the user verifies the information on the Acquisition Modality console. In the Modality/Evidence Images Stored transaction this information will be included in the header of the generated objects (See RAD-TF 2: 4.8 and RAD-TF 2: Appendix A).

4.1.2 Use Case Roles

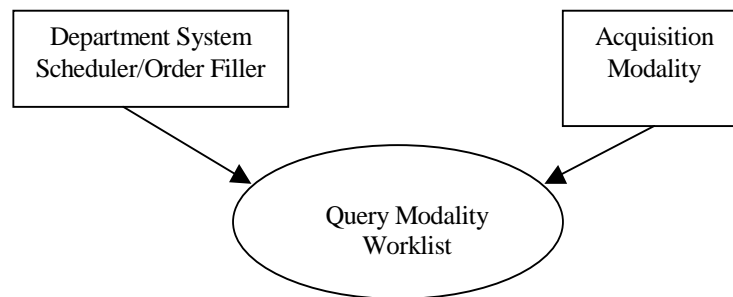

Actor: Acquisition Modality

Role: Responsible for requesting and receiving data from the Department System Scheduler/Order Filler, with the ability to validate the data and correct some discrepancies.

Actor: Department System Scheduler/Order Filler

Role: Responsible for accepting requests for MWL from an acquisition modality, performing the query, and sending the response back.

4.1.3 Referenced Standards

DICOM 2007 PS 3.4: Modality Worklist SOP Class

4.1.4 Interaction Diagram

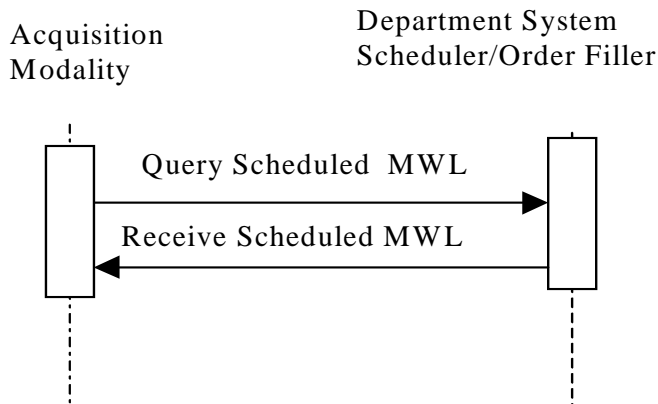

4.1.4.1 Query Scheduled MWL Message

This is the worklist query message sent to the Department System Scheduler/Order Filler.

4.1.4.1.1 Trigger Events

The patient arrives at the Acquisition Modality for a procedure.

4.1.4.1.2 Message Semantics

The Acquisition Modality uses the C-FIND Request of the DICOM Modality Worklist SOP Class to query for the worklist from the Department System Scheduler/Order Filler (DSS/Order Filler). The Acquisition Modality performs the SCU role, and the DSS/Order Filler the SCP role. The types of queries specified are defined in the RAD-TF 2: 4.5.

4.1.4.1.3 Expected Actions

The expected actions are defined in RAD-TF 2: 4.5. This section provides some further explanation for one eye care use case.

Various types of acquisition devices are able to create ophthalmic photography images and/or ophthalmic tomography images. For example, both fundus cameras and slit-lamp biomicroscopes are able to create ophthalmic photography images. When performing Modality Worklist clinics may desire to schedule protocols for each device separately (i.e. see a separate list for the fundus and slit-lamp biomicroscopes). This use case is solved in most specialties by using the Modality attribute in the MWL query; however, since the modality for each device is OP, this does not satisfy the use case in eye care. The solution to this use case is the DSS/OF managing the attribute Scheduled Station AE Title.

The Scheduled Station AE Title attribute is used to determine the actual device asking the MWL query. If the clinic wishes to schedule each device separately, then the Scheduled AE Title is used to distinguish between devices. However, this is not a very common case and more common is when a clinic wishes to schedule based upon device type. For this scenario, the DSS/OF provides the solution by creating a table of AE Titles for each type of similar device. Therefore, when the fundus camera and slit-lamp biomicroscope acquisition modalities use Scheduled Station AE Title in their MWL query, they will each receive a different list of scheduled procedures. This is just one scenario for how the DSS/OF should manage the attribute Scheduled Station AE Title. Others may also be required based upon the needs of the clinic.

4.1.5 Issuer of Patient ID

The ADT/Patient Registration actor transmits information regarding the assigning authority (issuer) of the Patient ID to the Order Filler Actor, this is defined in [RAD-1], see RAD-TF 2: 4.1). However, [RAD-5] (see RAD-TF 2: 4.5), does not required the DICOM attribute “Issuer of Patient ID” be filled in by the Order Filler actor if asked by the Acquisition Modality during a Modality Worklist query. This extension requires support for this attribute. See EYECARE-TF 1: 3.3.1 for use case explanation.

For this EYECARE-1 extension, table 4.5-3 from [RAD-5], (see RAD-TF 2: 4.5), shall be extended as defined by the following table entry.

Table 4.1.5-1 Return and Matching Keys For Modality Worklist

Attribute Name	Tag	Query Keys Matching		Query Keys Return	
		SCU	SCP	SCU	SCP
Patient Identification					
Issuer of Patient ID	(0010,021)	O	O	O	R+

Note: The Acquisition Modality is not required to ask for the Issuer of Patient ID in its query, however, if it does ask for the attribute, the Order Filler is required to return a valid value in the response.

4.2 Modality Images/Evidence Stored [EYECARE-2]

This transaction is identical to Modality Images Stored [RAD-8] (see RAD-TF 2: 4.8) except for the list of SOP Classes supported which are defined in later sections.

4.2.1 Scope

In the Modality Images/Evidence Stored transaction, the Acquisition Modality sends the acquired images/evidence documents to the Image Archive. The information provided from the Modality Worklist transaction (see RAD-TF 2: 4.5) shall be included in the headers of the generated images.

4.2.2 Use Case Roles

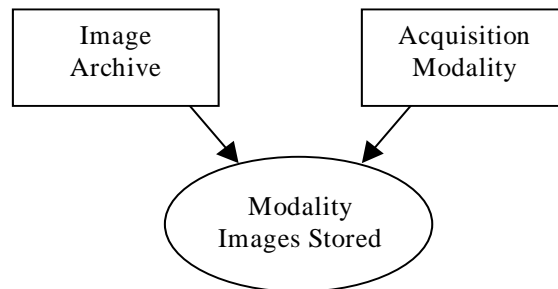

Actor: Acquisition Modality

Role: Transmit acquired image/evidence documents data to Image Archive.

Actor: Image Archive

Role: Accept and store images/evidence documents from Acquisition Modalities.

4.2.3 Referenced Standards

DICOM 2007 PS 3.4: Storage Service Class.

4.2.4 Interaction Diagram

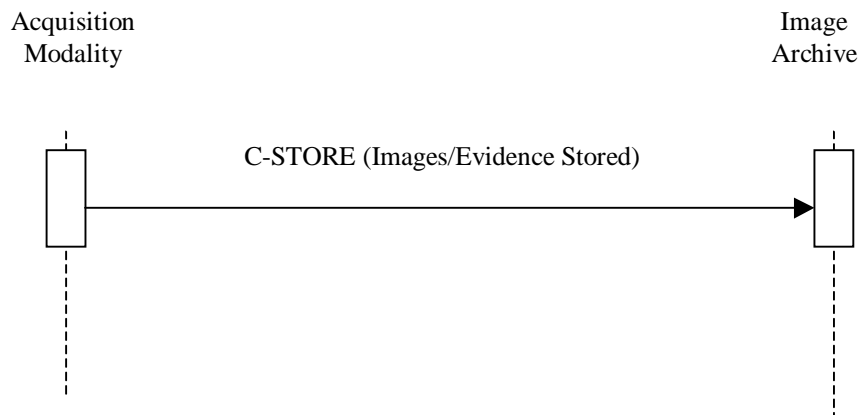

4.2.4.1 Images/Evidence Stored

4.2.4.1.1 Trigger Events

The Acquisition Modality can transfer images/evidence documents to the Image Archive sequentially within one or more DICOM associations, as the images/evidence documents become available or collectively.

4.2.4.1.1.1 Study UIDs and Series UIDs

Study UID creation details and timing are clearly defined by the IHE. The Radiology Scheduled Workflow and Patient Reconciliation Profiles explain how the Study information and identifiers such as the Study Instance UID are generated by the Order Filler and made available to the modality through the Modality Worklist. Generation of these items by the modality or workstation are restricted in general and are only permitted in specifically outlined exception cases, when a PPS is unscheduled (RAD-TF 2: Appendix A, Table A.1-2) or when several SPS belonging to different Requested Procedures are satisfied by a single PPS (RAD-TF 2: Appendix A, Table A.1-5).

Series UID creation must be compatible with a number of DICOM rules.

Multiple performed procedure steps are not permitted to reference the same series. So conversely, one series cannot contain the output of different performed procedure steps. Therefore, adding images/evidence documents to a series in a procedure step, which has been completed, is not permitted since a procedure step cannot be modified.

Note that a series *may* fulfill more than one *scheduled* procedure step.

Adding images/evidence documents after completion of a procedure step shall trigger the creation of a new series.

One series cannot contain the output of different equipment (in part because a series must have a single Frame Of Reference). Creating images/evidence documents on different equipment shall trigger the creation of a new series.

All images in a series must share the same Frame Of Reference. Generally this means creating images with different patient positioning shall trigger the creation of a new series. Note that if the Frame Of Reference is not present (at the Series level), this requirement is avoided.

Images/evidence documents reconstructed on a different piece of equipment are required to be in a separate Series.

For consistency, IHE specifies that derived and/or reconstructed images shall be stored in a separate series from the acquired images from which they were derived/reconstructed, regardless of whether they are derived/reconstructed on the Acquisition Modality or an Evidence Creator.

Note: Reconstructed and derived eye care image examples can include but are not limited to: mosaics, panoramas, 2-D/3-D renderings, superimposed images, combined images, statistical image maps, interpolated images, etc.

4.2.4.1.2 Message Semantics

The Acquisition Modality uses the DICOM C-STORE message to transfer the images/evidence documents. The Acquisition Modality is the DICOM Storage SCU and the Image Archive is the DICOM Storage SCP.

The user validates the available information for the patient and the Scheduled Procedure Step/Requested Procedure. It is a requirement that certain information be recorded in the object header of the image/evidence document. The details of the mapping to DICOM image/evidence documents instances are specified in Rad-TF 2: Appendix A. Effectively, this appendix strengthens the type definition of some DICOM attributes for the IHE Technical Framework

4.2.4.1.3 Issuer of Patient ID into Stored Images or Evidence Documents

EYECARE-1 defines the ability for Acquisition Modalities to query for the attribute Issuer of Patient ID using DICOM Modality Worklist, see section 4.1 for the specification. This section defines the requirement that this attribute be placed in the images and/or evidence documents if obtained via the query worklist.

If an Acquisition Modality actor obtains a valid value for the attribute Issuer Of Patient ID (0010,00210) via the Query Worklist Transaction, it shall include this attribute in any images and/or evidence documents it creates related to this specific patient.

4.2.5 EYE CARE Image Option

Acquisition Modalities that support the EYE CARE Image option shall support at least one of the SOP Classes defined by table 4.2.5-1 and 4.2.5-3.

Acquisition Modalities that support the EYE CARE Image Option to create Ophthalmic Photography Images shall be able to support Ophthalmic 8 bit Photography and/or Ophthalmic 16 bit Photography Image Storage.

Acquisition Modalities that support the EYE CARE Image Option to create Ophthalmic Tomography Images shall be able to support Ophthalmic Tomography Image Storage.

Acquisition Modalities that support the EYE CARE Image Option specified in table 4.2.5-1 shall be able to negotiate and offer the JPEG Baseline (Process 1): Default Transfer Syntax for Lossy JPEG 8 Bit Image Compression and JPEG Lossless, Non-Hierarchical, First-Order Prediction (Process 14 [Selection Value 1]): Default Transfer Syntax for Lossless JPEG Image Compression Transfer Syntaxes (see table 4.2.5-2). The use of compression is the decision of the site; therefore, the Acquisition Modalities shall also be required to turn off compression negotiation (based on site choices).

Note: We expect compression to be an evolving technology; therefore, requirement for supporting Transfer Syntaxes may be modified in the future.

Image Archives that support the EYE CARE Image Option shall support all of the SOP classes listed in Table 4.2.5-1 and 4.2.5-3.

Image Archives that support the EYE CARE Image Option shall be able to negotiate, offer and accept 2 compression transfer syntaxes:

- 1) JPEG Baseline (Process 1): Default Transfer Syntax for Lossy JPEG 8 Bit Image Compression
- 2) JPEG Lossless, Non-Hierarchical, First-Order Prediction (Process 14 [Selection Value 1]): Default Transfer Syntax for Lossless JPEG Image Compression (see table 4.2.5-2)

Table 4.2.5-1. EYE CARE Storage SOP Classes

SOP Class UID	SOP Class Name
1.2.840.10008.5.1.4.1.1.6.1	Ultrasound Image Storage
1.2.840.10008.5.1.4.1.1.3.1	Ultrasound Multi-frame Image Storage
1.2.840.10008.5.1.4.1.1.77.1.5.1	Ophthalmic 8 bit Photography Image Storage
1.2.840.10008.5.1.4.1.1.77.1.5.2	Ophthalmic 16 bit Photography Image Storage
1.2.840.10008.5.1.4.1.1.88.33	Stereometric Relationship Storage

Table 4.2.5-2. EYE CARE Compression Transfer Syntaxes

SOP Class UID	SOP Class Name
1.2.840.10008.1.2.4.50	JPEG Baseline (Process 1): Default Transfer Syntax for Lossy JPEG 8 Bit Image
1.2.840.10008.1.2.4.70	JPEG Lossless, Non-Hierarchical, First-Order Prediction (Process 14 [Selection Value 1]): Default Transfer Syntax for Lossless JPEG Image Compression

Table 4.2.5-3. EYE CARE Storage SOP Classes

SOP Class UID	SOP Class Name
1.2.840.10008.5.1.4.1.1.77.1.5.4	Ophthalmic Tomography Image Storage

4.2.6 Encapsulated PDF Option for Evidence Documents

There are many Acquisition Modalities that create evidence documents in addition to or instead of standalone images such as derived images, combined data, measurements, plots, graphs and other diagnostic information.

Acquisition Modalities that support the Encapsulated PDF option shall support the SOP Class defined by table 4.2.6-1.

In 2008, DICOM SOP Classes have been defined for many devices that create measurements, such as lensometers, auto-refractors, keratometers, and subjective refraction devices. Therefore, they are required to support the Eye Care Measurements Option defined in section 4.2.8. Image Archives that support the Encapsulated PDF option shall support the SOP Class defined by table 4.2.6-1.

Table 4.2.6-1. Eye Care SOP Classes for Evidence Documents

SOP Class UID	SOP Class Name
1.2.840.10008.5.1.4.1.1.104.1	Encapsulated PDF Storage

4.2.6.1 Encapsulated PDF Option for Evidence Documents Attributes

4.2.6.1.1 Concept Name Code Sequence

The Concept Name Code Sequence is the attribute used to provide standardized coded titles for documents. Report Creators which support the Encapsulated PDF option should be able to configure this attribute based upon the clinic requirements or a chosen industry standard.

Note: This requirement allows users and implementations to identify the different types of encapsulated documents.

4.2.7 Eye Care Measurements Option

There are many Acquisition Modalities in eye care that create measurement information, such as lensometers, auto-refractors, keratometers, and subjective refraction devices. This option allows support for such devices.

Acquisition Modalities that support the EYE CARE Measurements option shall support at least one of the SOP Classes defined by table 4.2.8-1.

Image Archives that support the EYE Care Measurements Option are required to support all the SOP Classes defined in table 4.2.8-1.

Table 4.2.8-1. EYE CARE Measurement Storage SOP Classes

SOP Class UID	SOP Class Name
1.2.840.10008.5.1.4.1.1.78.1	Lensometry Measurements
1.2.840.10008.5.1.4.1.1.78.2	Autorefracton Measurements
1.2.840.10008.5.1.4.1.1.78.3	Keratometry Measurements
1.2.840.10008.5.1.4.1.1.78.4	Subjective Refraction Measurements
1.2.840.10008.5.1.4.1.1.78.5	Visual Acuity Measurements
1.2.840.10008.5.1.4.1.1.78.6	Spectacle Prescription Report

4.3 Retrieve Images and Measurements [EYECARE-3]

This transaction is identical to Retrieve Images [RAD-16] (see RAD-TF 2: 4.16), with the addition of also retrieving refractive measurements.

4.3.1 Scope

After the Image Display request for retrieval, the requested DICOM Images and/or measurements are transferred from the Image Archive to the Image Display for viewing.

4.3.2 Use Case Roles

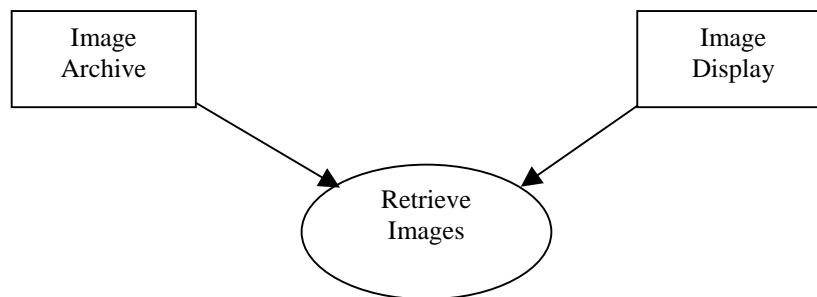

Actor: Image Archive:

Role: Sends requested images to the Image Display Actor.

Actor: Image Display

Role: Receives requested images from the Image Archive Actor.

4.3.3 Referenced Standards

DICOM 2007 PS 3.4: Storage Service Class

DICOM 2007 PS 3.4: Query/Retrieve Service Class

4.3.4 Interaction Diagram

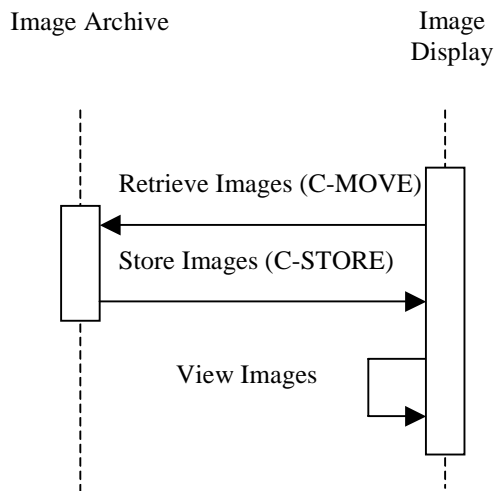

4.3.4.1 Retrieve Images

The Retrieve (Study Root – MOVE and optionally Patient Root – MOVE) SOP Classes shall be supported. The DICOM Image Storage SOP Classes will be supported by the Image Archive as an SCU. Refer to DICOM 2007 PS 3.4, Annex C, for detailed descriptive semantics.

4.3.4.1.1 Trigger Events

Images and/or measurements are selected for viewing at the Image Display.

4.3.4.1.2 Message Semantics

The message semantics are defined by the DICOM Query/Retrieve SOP Classes and the DICOM Image and Measurements Storage SOP Classes.

A C-MOVE Request from the DICOM Study Root Query/Retrieve Information Model – MOVE SOP Class or the DICOM Patient Root Query/Retrieve Information Model – MOVE SOP Class shall be sent from the Image Display to the Image Archive.

4.3.4.1.3 Expected Actions

The Image Archive receives the C-MOVE request, establishes a DICOM association with the Image Display and uses the C-STORE request (for the appropriate DICOM Image and/or Measurements Storage SOP Classes) to transfer the requested images. The Image Display is

expected to support at least one of the SOP Classes specified in table 4.2.5-1 and/or 4.2.5-3 and/or 4.2.8-1. Support of retrieval for a SOP Class also means support for display.

4.3.5 EYE CARE Image Option

Image Display actors that support the EYE CARE Image Option shall support one or more of the SOP classes listed in Table 4.2.5-1 and/or 4.2.5-3 and/or 4.2.8-1. Other specialties, such as radiology, may obtain images of the eye. Examples include CTs, MR, X-Rays, etc. IHE EYECARE does not list these possibilities but recommends that Image Display actors be able to display such images. All Storage SOP classes supported by Image Display actors shall be documented in the DICOM conformance statement.

Note: A few examples are X-rays of an eye for foreign body , X-ray angiography to assess vascular orbital lesions, CT or MR of orbits, etc.

Image Display actors that support the EYE CARE Image Option shall be able to negotiate, offer and accept, the JPEG Baseline (Process 1): Default Transfer Syntax for Lossy JPEG 8 Bit Image Compression and JPEG Lossless, Non-Hierarchical First-Order Prediction (Process 14 [Selection Value 1]) Default Transfer Syntax for Lossless JPEG Image Compression (see table 4.2.5-2).

4.4 Query Evidence Documents [EYECARE-4]

This transaction is identical to Query Images [RAD-45] (see RAD-TF 3: 4.45), with the addition of querying for DICOM Encapsulated PDF document.

4.4.1 Scope

This section describes the sequence of Transactions required for the Image Display to query the Image Archive for instances of Evidence Documents.

4.4.2 Use Case Roles

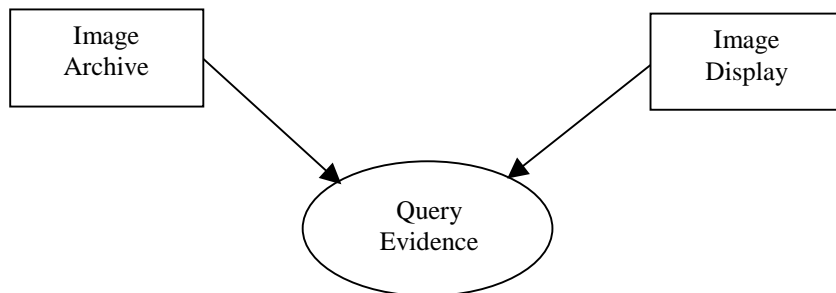

Actor: Image Display

Role: Query for Evidence Documents objects (generally in order to retrieve them).

Actor: Image Archive

Role: Respond to queries from the Image Display for Evidence Documents objects.

4.4.3 Referenced Standards

DICOM 2007 PS 3.4: Query/Retrieve Service Class

4.4.4 Interaction Diagram

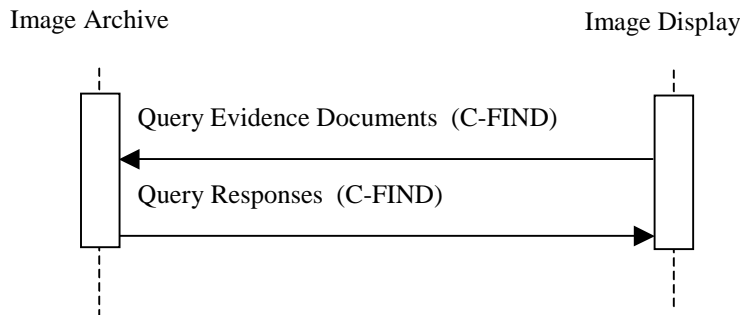

4.4.4.1 Query Evidence Documents

The Query (Study Root – FIND and optionally Patient Root – FIND) SOP Classes shall be supported. Refer to DICOM 2007 PS 3.4: Query/Retrieve Service Class for detailed descriptive semantics.

4.4.4.1.1 Trigger Events

Image Display needs to obtain information about Evidence Documents.

4.4.4.1.2 Message Semantics

The message semantics are defined by the DICOM Query/Retrieve SOP Classes.

A C-FIND Request from the DICOM Study Root Query/Retrieve Information Model – FIND SOP Class or the DICOM Patient Root Query/Retrieve Information Model – FIND SOP Class shall be sent from the Image Display to the Image Archive.

The Image Display uses one or more matching keys as filter criteria to obtain the list of matching entries in the Image Archive at the selected level (Patient & Study/Series/Instance).

In addition to the required and unique keys defined by the DICOM Standard, the IHE Technical Framework has defined matching and return keys to be supported by query SCUs and SCPs. The keys are defined in section RAD TF-2: 4.14.4.1.2 and table RAD TF-2: 4.14-1. The conventions for key usage are defined in RAD TF-2: 2.2. For the Image Display (SCU) and the Image Archive (SCP) the additional Evidence Document Instances specific keys are defined in table RAD TF-3: 4.44-1.

4.4.5 DICOM Encapsulated PDF Query Attributes

RAD-44 defines the ability for Evidence Creators (and other actors) to query Image Archives for evidence document information. This transaction is a simple extension to RAD-44 as it adds the support for DICOM Encapsulated PDF query attribute to display the Document Title.

Evidence Creators and Image Archives shall support the transaction as defined by RAD-44 with the addition of the requirements defined in table 4.4.5-1.

Table 4.4.5-1. Additional Query Matching and Return Keys for DICOM Encapsulated PDF Support

Attribute Name	Tag	Query Keys Matching		Query Keys Return	
		SCU	SCP	SCU	SCP
Encapsulated Document Instance Specific Level					
Document Title	(0042,0010)	O	O	R+	R+

Note: A workstation and/or acquisition modality supporting the Eye Care Evidence Document profile may perform a single query to obtain information about both images and evidence documents (i.e. two queries are not required). Similarly, when retrieving the information one retrieve could be used to obtain both images and evidence documents.

4.5 Query Images, Measurements and Encapsulated Documents [EYECARE-5]

This transaction is identical to Query Images [RAD-14] (see RAD-TF 2: 4.14), with the additional requirement that the Image Archive support the attribute Issuer Of Patient ID.

4.5.1 Scope

The Image Display queries the Image Archive for study, series and image instances for retrieval.

4.5.2 Use Case Roles

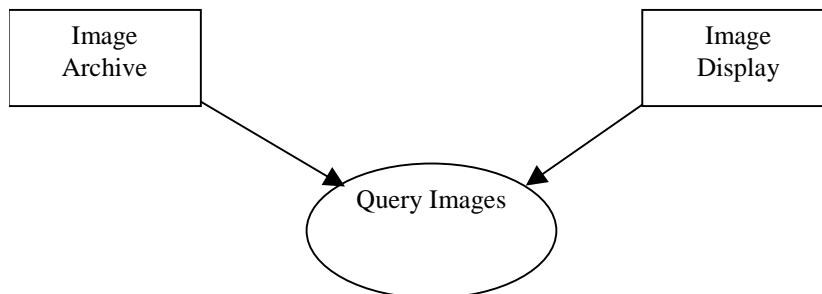

Actor: Image Archive

Role: Responds to queries for Studies, Series, and Images.

Actor: Image Display

Role: Issues Queries for Studies, Series, Images

4.5.3 Referenced Standards

DICOM 2007 PS 3.4: Query/Retrieve Service Class

4.5.4 Interaction Diagram

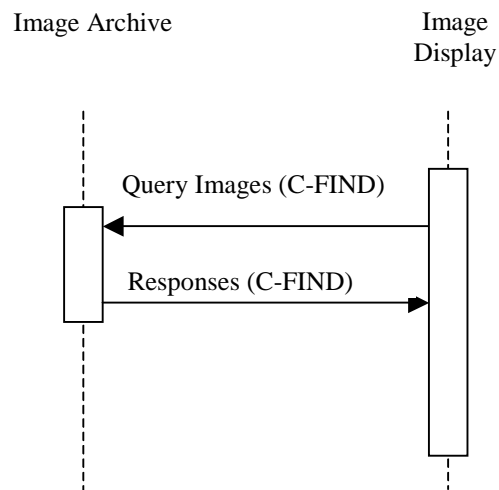

4.5.4.1 Query Images, Measurements and Encapsulated Documents

The Query (Study Root – FIND and optionally Patient Root – FIND) SOP Classes shall be supported. Refer to DICOM 2007 PS 3.4 for detailed descriptive semantics.

4.5.4.1.1 Trigger Events

The user at the Image Display wishes to view selected images.

4.5.4.1.2 Message Semantics

The message semantics are defined by the DICOM Query/Retrieve SOP Classes.

A C-FIND Request from the DICOM Study Root Query/Retrieve Information Model – FIND SOP Class or optionally the DICOM Patient Root Query/Retrieve Information Model – FIND SOP Class shall be sent from the Image Display to the Image Archive. Hierarchical Search Method shall be supported.

The Image Display uses one or more matching keys as search criteria to obtain the list of matching entries in the Image Archive at the selected level (Patient & Study/Series/Image). Based on this list of entries, the Image Display may select relevant entries to be retrieved.

The matching keys and return keys to be supported by the Image Display (SCU) and the Image Manager (SCP) are defined in the table defined in [RAD-14] (see RAD-TF 2: 4.14), . The table specifies for both the Query SCU (Image Display) and the Query SCP (Image Archive) if Matching Keys (keys used as matching criteria in the Query request) and Returned Keys (Keys used to request attributes to be returned in the query responses) are Required (R) or Optional (O).

4.5.5 Support Issuer of Patient ID

RAD-14 defines the ability for Image Display actors to query Image Archives for images. This transaction is a simple extension to RAD-14 as it adds the support for the attribute Issuer of Patient ID.

Image Display and Image Archives shall support the transaction as defined by RAD-14 with the addition of the requirements defined in table 4.5.5-1.

Table 4.5-1. Images Query Matching and Return Keys

Attributes Name	Tag	Query Keys Matching		Query Keys Return		Notes
		SCU	SCP	SCU	SCP	
Study Level						
Issuer Of Patient ID	(0010,0020)	O	O	O	R+	See Note 1

Note: The Image Display is not required to ask for the Issuer of Patient ID in its query, however, if it does ask for the attribute, the Order Filler is required to return a valid value in the response (if it exists).

4.6 Modality Procedure Step Completed/Discontinued [EYECARE-6]

This transaction is identical to Modality Procedure Step Completed [RAD-7] (see RAD-TF 2: 4.7), with the additional requirement that that Acquisition Modalities conveys the attribute Performed Protocol Code Sequence in the MPPS message. The Department System Scheduler/Order Filler, Image Manager, Performed Procedure Step Manager and Acquisition Modality actors use transaction EYECARE-6.

4.6.1 Scope

This transaction includes a message from the Acquisition Modality to the Performed Procedure Step Manager, which in turn issues messages to the DSS/Order Filler and the Image Manager that the Performed Procedure Step has been completed. Information is not being released for billing at this point but a code may be assigned. The Image Manager may need the information to co-locate images of the same study. The Modality Procedure Step Completed message does not necessarily mean that the set of images is complete or available for retrieval.

4.6.2 Use Case Roles

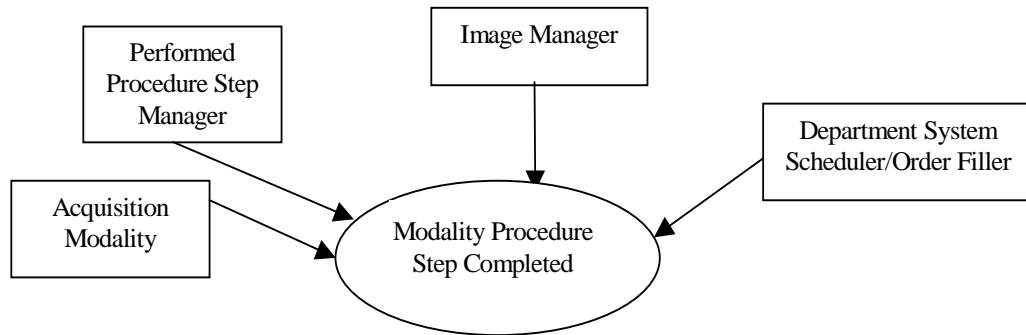

Actor: Department System Scheduler/Order Filler.

Role: Receives the PPS information forwarded by the PPS Manager.

Actor: Image Manager.

Role: Receives the PPS information forwarded by the PPS Manager.

Actor: Acquisition Modality.

Role: Informs the Performed Procedure Step Manager that a particular Performed Procedure Step is completed.

Actor: Performed Procedure Step Manager.

Role: Accepts Performed Procedure Step information from an Acquisition Modality and transmits it to the Department System Scheduler/Order Filler and Image Manager.

4.6.3 Referenced Standards

DICOM 2007 PS 3.4: Modality Performed Procedure Step SOP Class.

DICOM 2007 PS 3.16: DCMR Context Groups (Normative)

4.6.4 Interaction Diagram

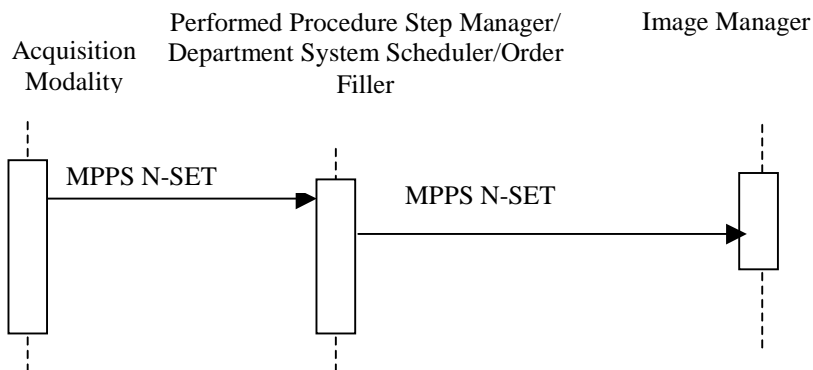
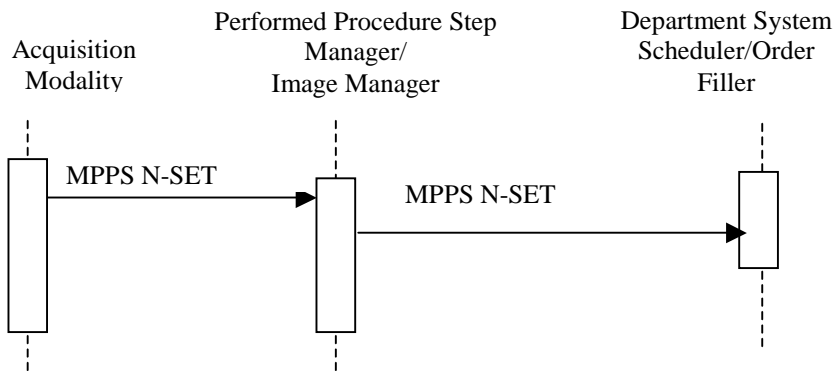

Note: The diagram above shows the sequencing of messages for the Modality Performed Procedure Step SOP Class. Acquisition Modalities will also implement the Storage and Storage Commitment classes. The timing relationship between PPS messages and Storage and Storage Commitment messages is not specified. That is, PPS messages may occur before or after storage requests.

4.6.4.1 Modality Procedure Step Completed/Discontinued [EYECARE-6]

RAD-7 defines the requirements and options for supporting Modality Procedure Step Completed/Discontinued. This transaction is a simple extension to RAD-7 as it adds the additional requirement that Acquisition Modalities convey the attribute Performed Protocol Code Sequence in the MPPS message.

Department System Scheduler/Order Filler, Image Manager, Performed Procedure Step Manager and Acquisition Modality actors are required to support RAD-7 as defined in RAD-TF 2: 4.7 with the following extensions.

4.6.4.2 Performed Protocol Code Sequence

A Modality Protocol Table shall be configured on the Acquisition Modality Actor. This table shall be synchronized with the Image Manager and the Department System Scheduler/Order Filler Actors.

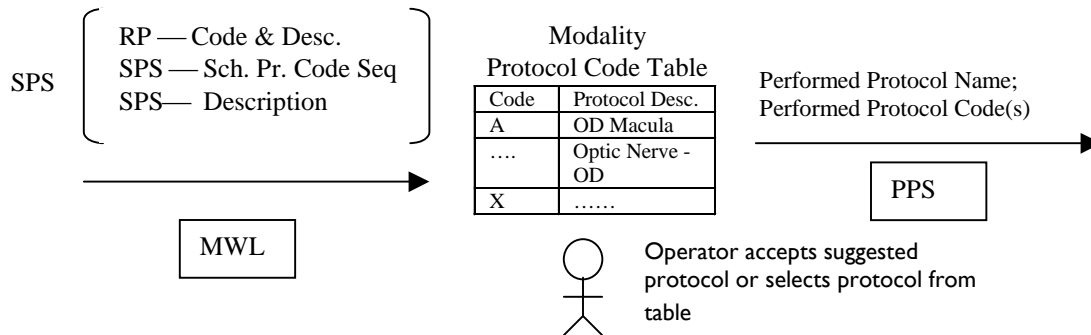

Upon obtaining a MWL from the Department System Scheduler/Order Filler the Acquisition Modality is required to display the attributes Scheduled Protocol Code Sequence and Scheduled Procedure Step Description (this requirement is part of RAD-5 and EYECARE-1].

For this requirement, the modality operator shall either accept/select the protocol proposed in attribute Scheduled Protocol Code Sequence or select an alternative protocol defined in the list of possibilities from Modality Protocol Table. The operator shall not manually enter the attributes (i.e. type in the protocol code) of the acquisition protocol but use the list from the Modality Protocol Table. This simplifies the operator’s work on the modality and enables a better management of the protocols used in an imaging department. The Acquisition Modality actor shall provide the selected protocol code value in the attribute Performed Protocol Code Sequence in addition to the Protocol Name. This feature facilitates the role of the Department System Scheduler/Order Filler within the Charge Posting Integration Profile.

This feature does not define a specific codification of acquisition protocols. The involved actors, Department System Scheduler, Acquisition Modality, and Image Manager/Archive shall be configurable in order to support the codification scheme selected or defined by the healthcare enterprise.

4.6.4.3 Trigger Event

Operator completes procedure step from the Acquisition Modality console.

4.6.4.4 Message Semantics

The Acquisition Modality uses the Modality Performed Procedure Step SOP Class (N-SET service) to inform the Performed Procedure Step Manager that a specific Performed Procedure Step has been completed or discontinued. The Acquisition Modality may use the MPPS N-SET service to send intermediate updates of the Performed Procedure Step information.

The final N-SET has either the MPPS status of "COMPLETED" or "DISCONTINUED". The Performed Procedure Step Manager sends corresponding N-SETs to the Department System Scheduler/Order Filler and Image Manager.

When an N-SET is issued with a "DISCONTINUED" status, one or more Series of Instances may be referenced, if images were created and sent. Those Instances shall be Stored and Storage Committed

Along with other information, the Acquisition Modality shall transmit information about the protocol it used to produce the SOP instances to the recipients. See Protocol Handling in section RAD-TF 2: 4.6.4.1.2.4 for detailed discussion of this issue.

Note: DICOM specifies that when attributes are allowed to be set by an N-SET, the value provided by the last N-SET overrides any value set by an earlier N-CREATE or N-SET.

4.6.4.4.1 Expected Actions

The Image Manager and Department System Scheduler/Order Filler receive information about the Performed Procedure Step being complete or discontinued and link it with the Requested Procedure and Scheduled Procedure Step. The Image Manager and Department System Scheduler are not required to act on intermediate N-SET messages with the MPPS Status "IN PROGRESS".

The Requested Procedure may be considered complete if all Performed Procedure Steps related to all Scheduled Procedure Steps have been completed (or properly discontinued). Additional new (unscheduled) Performed Steps may be performed at any time, even after the Requested Procedure has been assigned complete scanning status. See relationship between Scheduled and Performed Procedure Steps in sec. RAD-TF 2: 4.6.4.1.2.3 for detailed discussion of this issue.

4.7 Displayable Report Storage [EYECARE-7]

This section corresponds to Transaction EYECARE-7 of the IHE Technical Framework. Transaction EYECARE-7 is used by the Report Creator and Report Repository actors.

4.7.1 Scope

In the Report Storage transaction, the Report Creator transmits a DICOM Encapsulated Document object to the Report Repository.

4.7.2 Use Case Roles

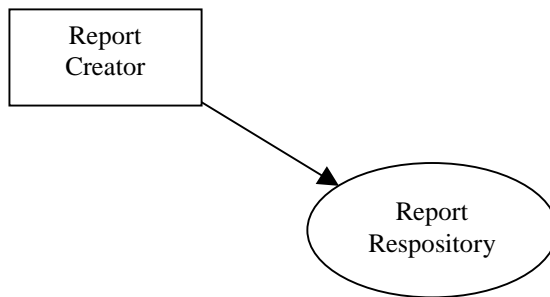

Actor: Report Creator

Role: Transmit draft or final DICOM Encapsulated document Reports to Report Repository.

Actor: Report Repository

Role: Receive draft and final DICOM Encapsulated document Reports for storage

4.7.3 Referenced Standards

DICOM 2007 PS 3.4: Storage SOP Class

4.7.4 Interaction Diagram

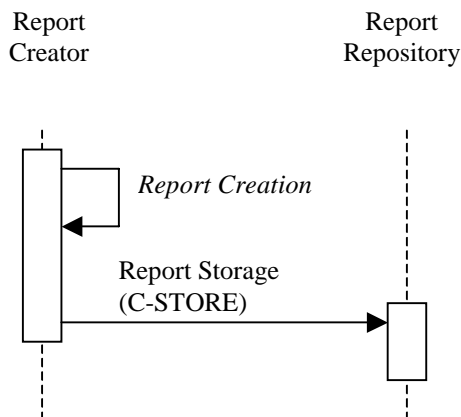

4.7.4.1 Report Creation

This transaction relates to the "Report Creation" event in the above interaction diagram.

4.7.4.1.1 Trigger Events

The user at the Report Creator wishes to create a clinical report using DICOM Encapsulated Document.

4.7.4.1.2 Invocation Semantics

This is a local invocation of functions at the Report Creator, and the method used by the Report Creator to obtain report data and create a DICOM Encapsulated document object is outside the scope of the IHE Technical Framework. The Report Creator shall create a report that conforms to the DICOM Encapsulated document defined in section 4.7.5.

4.7.4.1.3 Expected Actions

Creation of DICOM Encapsulated document objects ready for storage to the Report Repository.

4.7.4.1.3.1 Study Identification and Identical Documents Sequence

A Study Instance UID is required to identify the study to which the report belongs. It is recommended to use the Study Instance UID of the images and/or measurements reported on as the Study Instance UID of the created Encapsulated document. If a Report Creator is generating a single report for multiple studies, it shall create multiple copies of the report, with different SOP Instance UIDs for each report and use the Identical Documents Sequence attribute (0040,A525) in each report. The Identical Documents Sequence attribute (0040,A525) in each report shall reference each of the other identical reports in the other studies. The actual content of the report (except the Identical Documents Sequence attribute) shall be the same in each report instance.

The Retrieve AE Title attribute (0008,0054) in the Identical Documents Sequence Items shall not be sent.

4.7.4.2 Report Submission

This transaction relates to the “DICOM C-STORE” event between the Report Creator and Report Repository in the above interaction diagram.

4.7.4.2.1 Trigger Events

When report authoring is completed and the Report Creator creates a new DICOM Encapsulated document the Report Creator shall transfer the DICOM Encapsulated document to the Report Repository.

4.7.4.2.2 Message Semantics

The Report Creator uses the DICOM C-STORE message to transfer DICOM Encapsulated document reports. The DICOM Encapsulated document Instance shall include the additional attributes shown in Table 4.7.5-1. The Report Repository shall support Level 2 (Full) storage, which means all DICOM Type 1, 2 and 3 and private attributes are stored.

4.7.4.2.3 Expected Actions

The Report Repository shall store the received DICOM Encapsulated document objects. At this point, the Report Creator relinquishes any responsibility for the report objects and may not change them in any way without creating a new object with a new SOP Instance UID. The Report Repository shall make the Instances available for query and retrieve.

4.7.5 DICOM Encapsulated Document Standard Extended Attributes

The Report Creator and Report Repository shall support the DICOM SOP Classes defined in Table 4.7.5-1 and the Standard Extended Attributes defined in table 4.7.5-2.

Table 4.7.5-1. SOP Classes for Encapsulated Documents

SOP Class UID	SOP Class Name
1.2.840.10008.5.1.4.1.1.104.1	Encapsulated PDF Storage

Table 4.7.5-2 DICOM Encapsulated Documents Standard Extended Attributes

Attribute Name	Tag	Type	Attribute Description
Verification Flag	(0040,A493)	1	Indicates whether this Document is Verified. Enumerated Values: UNVERIFIED = Not attested to. VERIFIED = Attested to by a Verifying Observer Name (0040,A075) who is accountable for its content. Note: The intent of this specification is that the "prevailing final version" of a Encapsulated Document is the version having the most recent Verification DateTime (0040,A030), Completion Flag (0040,A491) of COMPLETE and Verification Flag (0040,A493) of VERIFIED. Note: Eye care has made this attribute a Type 1 field, as it is only Type 3 in the Encapsulated IOD definition.
Content Date	(0008,0023)	1	The date the document content creation started. Note: Eye care has made this attribute a Type 1 field, as it is only Type 2 in the Encapsulated IOD definition.
Content Time	(0008,0033)	1	The time the document content creation started. Note: Eye care has made this attribute a Type 1 field, as it is only Type 2 in the Encapsulated IOD definition.

Completion Flag	(0040,A491)	1	The estimated degree of completeness of this Document with respect to externally defined criteria in a manner specified in the Conformance Statement. Note: It may be desirable to make these criteria adaptable to local policies or user decisions. Enumerated Values: PARTIAL = Partial content. COMPLETE = Complete content.
Completion Flag Description	(0040,A492)	3	Explanation of the value sent in Completion Flag (0040,A491).
Verifying Observer Sequence	(0040,A073)	1C	The person or persons authorized to verify documents of this type and accept responsibility for the content of this document. One or more Items may be included in this sequence. Required if Verification Flag (0040,A493) is VERIFIED.
>Verifying Observer Name	(0040,A075)	1	The person authorized by the Verifying Organization (0040,A027) to verify documents of this type and who accepts responsibility for the content of this document.
>Verifying Observer Identification Code Sequence	(0040,A088)	2	Coded identifier of Verifying Observer. Zero or one Items shall be permitted in this sequence.
<i>>>Include 'Code Sequence Macro' Table 8.8-1 (in DICOM Standard Part 3)</i>		<i>No Baseline Context ID defined.</i>	
>Verifying Organization	(0040,A027)	1	Organization to which the Verifying Observer Name (0040,A075) is accountable in the current interpretation procedure.
>Verification DateTime	(0040,A030)	1	Date and Time of verification by the Verifying Observer Name (0040,A075).
<i>>Include 'SOP Instance Reference Macro' Table C.17-3 (in DICOM Standard Part3)</i>			
Current Requested Procedure Evidence Sequence	(0040,A375)	3	Full set of Composite SOP Instances, of which the creator is aware, which were created to satisfy the current Requested Procedure(s) for which this Document is generated or that are referenced in the content tree. One or more Items may be included in this sequence.
<i>>Include 'SOP Instance Reference Macro' Table C.17-3</i>			
Pertinent Other Evidence Sequence	(0040,A385)	3	Other Composite SOP Instances that are considered to be pertinent evidence by the creator of this Document. This evidence must have been acquired in order to satisfy Requested Procedures other than the one(s) for which this Document is generated. One or more Items may be included in this sequence.
Identical Documents Sequence	(0040,A525)	1C	Duplicates of this document, stored with different SOP Instance UIDs. One or more Items may be included in this sequence. Required if this document is stored with different SOP Instance UIDs in one or more other Studies.

>Include 'SOP Instance Reference Macro' Table C.17-3 (in DICOM Standard Part 3)

4.7.5.1 Encapsulated Documents Attributes Extensions

4.7.5.2 Concept Name Code Sequence

The Concept Name Code Sequence is the attribute used to provide standardized coded titles for documents. For this transaction, the Report Creator is required to be able to configure this attribute based upon the clinic requirements or a chosen industry standard.

Note: This requirement allows users and implementations to identify the different types of encapsulated documents.

4.7.5.3 Source Instance Sequence

The Source Instance Sequence is the attribute used to reference derived encapsulated documents. This attribute shall refer to SOP Instances (e.g. prior or provisional reports) whose content has been wholly or partially included in the Encapsulated document. This amendment process of a document is not explicitly described, however, the use of this attribute allows tracking back to the previous version of this document.

4.8 Query Displayable Report [EYECARE-8]

This section corresponds to Transaction EYECARE-8 of the IHE Technical Framework. Transaction EYECARE-8 is used by the Report Reader and Report Repository actors.

4.8.1 Scope

In the Query Displayable Reports Transaction, the Report Reader queries the Report Repository for draft or final DICOM Encapsulated document.

4.8.2 Use Case Roles

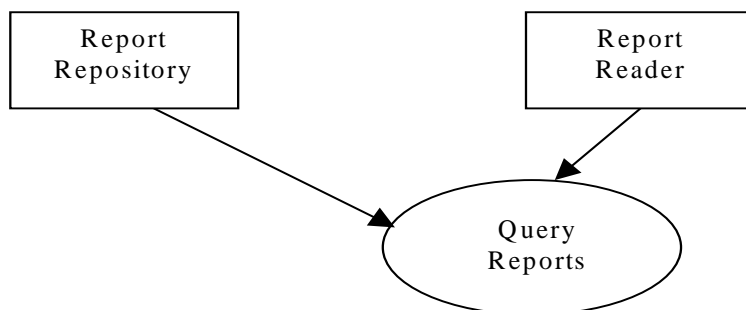

Actor: Report Repository

Role: Responds to queries for DICOM Encapsulated document.

Actor: Report Reader

Role: Queries Report Repository for DICOM Encapsulated documents and makes them available for selection.

4.8.3 Referenced Standards

DICOM 2007 PS 3.4: Query/Retrieve Service Class

4.8.4 Interaction Diagram

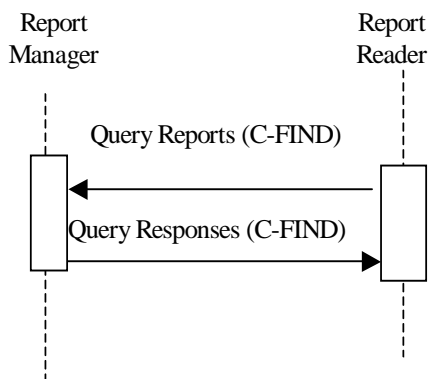
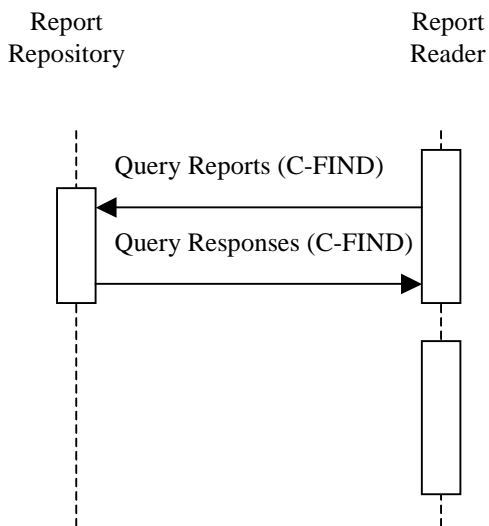

4.8.4.1 Query Displayable Reports

This transaction relates to the query section of the above interaction diagram. The Query (Study Root – FIND and optionally Patient Root – FIND) SOP Classes will be supported. Refer to DICOM 2007 PS 3.4: Query/Retrieve Service Class for detailed descriptive semantics.

4.8.4.1.1 Trigger Events

The user at the Report Reader wishes to view selected reports.

4.8.4.1.2 Message Semantics

The message semantics are defined by the DICOM Query/Retrieve SOP Classes.

A C-FIND Request from the DICOM Study Root Query/Retrieve Information Model – FIND SOP Class or the DICOM Patient Root Query/Retrieve Information Model – FIND SOP Class shall be sent from the Report Reader to the Report Repository.

The Report Reader uses one or more matching keys as search criteria to obtain the list of matching entries in the Report Repository at the selected level (Patient & Study/Series/Instance).

In addition to the required and unique keys defined by the DICOM Standard, the IHE Technical Framework has defined matching and return keys to be supported by query SCUs and SCPs. The keys are defined in [RAD-14] (see RAD-TF 2: 4.14), except that Report Reader and Report Repositories are not required to support PPS Start Date and PPS Start Time. The conventions for key usage are defined in section 2.2. For the Report Reader (SCU) and the Report Repository (SCP) the additional document Instance specific keys are defined in table 4.8-1.

Table 4.8-1. Document Instance Specific Query Matching and Return Keys

Attribute Name	Tag	Query Keys Matching		Query Keys Return	
		SCU	SCP	SCU	SCP
SR Instance Specific Level					
Document Title	(0042,0010)	O	O	R+	R+
Completion Flag	(0040,A491)	R+	R+	R+	R+
Verification Flag	(0040,A493)	R+	R+	R+	R+
Content Date	(0008,0023)	O	O	R+	R+
Content Time	(0008,0033)	O	O	R+	R+
Verifying Observer Sequence	(0040,A073)				
>Verifying Organization	(0040,A027)	O	O	R+	R+
>Verification DateTime	(0040,A030)	R+	R+	R+	R+
>Verifying Observer Name	(0040,A075)	R+	R+	R+	R+
>Verifying Observer Identification Code Sequence	(0040,A088)				
>> Code Value	(0008,0100)	O	O	O	R+
>> Coding Scheme Designator	(0008,0102)	O	O	O	R+

>> Coding Scheme Version	(0008,0103)	O	O	O	R+
>> Code Meaning	(0008,0104)	O	O	O	R+
Concept Name Code Sequence	(0040,A043)				
>Code Value	(0008,0100)	R+	R+	R+	R+
>Coding Scheme Designator	(0008,0102)	R+	R+	R+	R+
>Coding Scheme Version	(0008,0103)	O	O	O	R+
>Code Meaning	(0008,0104)	O	O	R+	R+

4.8.4.1.3 Expected Actions

The Report Repository receives the C-FIND request, performs the matching on the provided keys and sends the list of matching records back to the Report Reader via C-FIND responses.

4.9 Retrieve Displayable Reports [EYECARE-9]

This section corresponds to Transaction EYECARE-9 of the IHE Technical Framework. Transaction EYECARE-9 is used by the Report Reader and Report Repository actors.

4.9.1 Scope

In the Retrieve Displayable Reports Transaction, the requested DICOM Encapsulated documents are transferred from the Report Repository to the Report Reader for viewing.

4.9.2 Use Case Roles

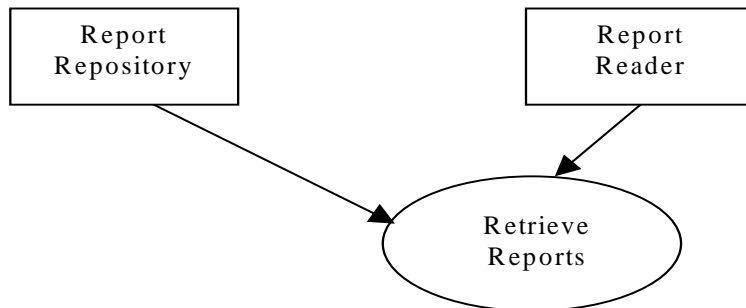

Actor: Report Repository

Role: Sends requested DICOM Encapsulated document to Report Reader.

Actor: Report Reader

Role: Retrieves DICOM Encapsulated document from Report Repository and makes them available for viewing.

4.9.3 Referenced Standards

DICOM 2007 PS 3.4: Query/Retrieve Service Class

DICOM 2007 PS 3.4: Storage SOP Class

4.9.4 Interaction Diagram

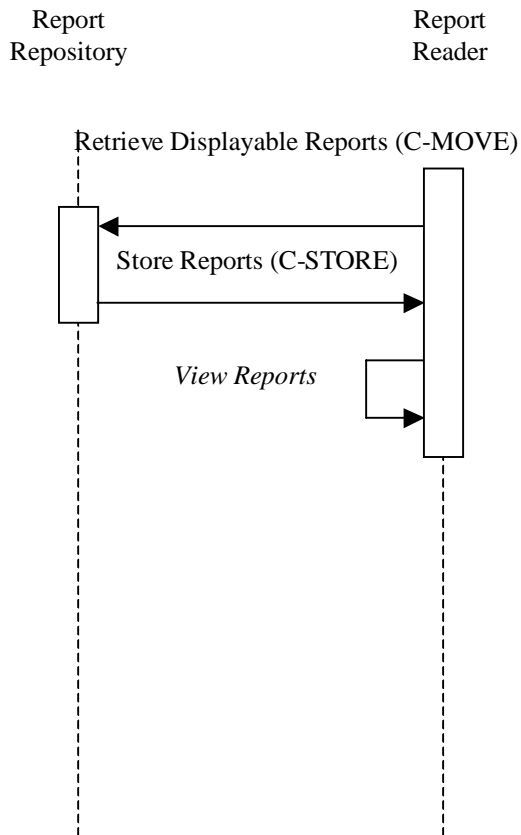

4.9.4.1 Retrieve Reports

This transaction relates to the retrieve section of the above interaction diagram. The Retrieve (Study Root – MOVE and optionally Patient Root – MOVE) SOP Classes shall be supported. The Report Reader as an SCP shall support the DICOM Encapsulated Document Storage SOP Class. The Report Repository as an SCU shall support DICOM Encapsulated Document Storage SOP Class. Refer to DICOM PS 3.4, Annex C, for detailed descriptive semantics.

4.9.4.1.1 Trigger Events

The user at the Report Reader selects specific reports to view.

4.9.4.1.2 Message Semantics

The DICOM Query/Retrieve SOP Classes and the DICOM Encapsulated Storage SOP Classes define the message semantics.

A C-MOVE Request from the DICOM Study Root Query/Retrieve Information Model – MOVE SOP Class or the DICOM Patient Root Query/Retrieve Information Model – MOVE SOP Class shall be sent from the Report Reader to the Report Repository.

4.9.4.1.3 Expected Actions

The Report Repository receives the C-MOVE request, establishes a DICOM association with the Report Reader and uses the appropriate DICOM Encapsulated Document Storage SOP Classes to transfer the requested reports.

Report Repository responds to the queries with the information from the DICOM instances it received from the Report Creator.

The Report Repository and Report Reader shall support the SOP Class(es) defined in table 4.7.5-1.

4.9.4.2 View Reports

This transaction relates to the “View Reports” event of the above interaction diagram.

4.9.4.2.1 Trigger Events

The Report Reader receives reports from the Report Repository.

4.9.4.2.2 Invocation Semantics

This is a local invocation of functions at the Report Reader, and the method used by the Report Reader to interpret and display the report data in a meaningful way is outside the scope of the IHE Technical Framework.

4.9.4.2.3 Expected Actions

The Report Reader presents to the user a DICOM Encapsulated document.